



Compact and quick to deploy, the inflatable Mass Decontamination Unit from MFC International allows for rapid response in a decontamination scenario.

Fully inflatable, the Decontamination Unit can be set up in a matter of minutes, and will stay standing without continuous inflation. With no mechanical framework the shelters are relatively lightweight to transport and compact to store.

The mass Decontamination shower is partitioned into three lanes (male, female & assisted casualty), with pre and post decon changing areas.

Partitions are removable and doors can be linked together allowing the shower to be configured as a single, double or triple lane system.

Raised floor panels prevent contact with contaminated shower wash-off, which is collected in a chemically resistant sump. Sleeves for pumped extraction of contaminated water are included as standard.

Showers can be used on hard or soft standing, and guy ropes are provided for securing in position during inclement weather.

FEATURES

- Compact and easily transportable
- Set up within a matter of minutes and will stay standing without continuous inflation
- Flexible internal partitioning with pre and post decontamination changing areas
- Raised floor panels in the shower prevent contact with contaminated shower wash off which is collected in a chemically resistant sump
- Sleeves for portable air heaters and pumped extraction of contaminated water are included as standard
- Shower nozzles are all on demand and can be turned on/off individually
- Windows on internal shower doors with covers, assisted (central) lane door includes zipped flap for transferring medical equipment

- Two inflation/deflation ports allows the use of ARS (automatic refilling system) inflaters for extended deployments
- Can be used on hard or soft standing
- Minimal training, servicing and maintenance costs

USED FOR

- Decontamination scenarios

SUPPLIED WITH

- Valise (590016)
- Repair kit (600008/01)
- Inflation hose - 1m (for use with 8 bar regulator) (HS-04-05-01-27-06)
- Accessories kit bag, containing galvanised ground fixing pegs, rubber mallet and hand pump

TECHNICAL DATA

	Mass Decon Unit
Product Code	● DSW027
	● DSW027/001
Length (cm)	726
Int. Length (cm)	726
Width (cm)	452
Int. Width (cm)	406
Height (cm)	302
Int. Height (cm)	278
Int. Floor Area (sq.m)	30
Air Requirements (ltr)	3800

Max. Water Inlet Pressure (bar)	3
Recommended Pump Flow-Capacity (ltrs)	5 ltr/min per nozzle
Number of Shower Nozzles	8
Number of Shower Hose/Brush Connectors	8
Number of Heater Sleeves	4
Number of Cable sleeves	8
Pack Size (cm)	160 x 100 x 80
Weight (kg)	140

- **CAMLOCK Coupling System**
For a system with CAMLOCK couplings throughout order codes in green
- **Storz Coupling System**
For a system with Storz D25 couplings throughout order codes in blue

DETAIL DRAWING

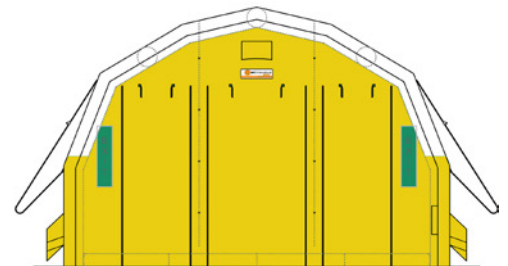
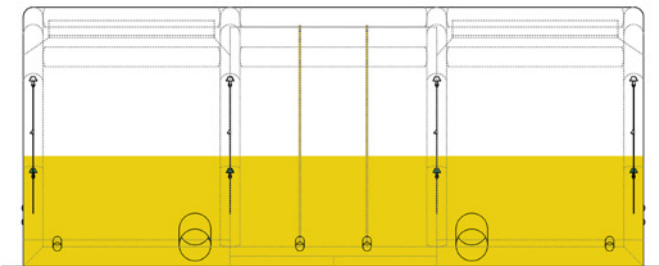

INTERNAL LAYOUT (3 LANE CONFIGURATION)

The diagram on the right shows the different compartments of the Mass Decontamination shower. It also shows how the user enters the decontamination shower and shows the direction of travel. The areas are colour coded:

- **Red** - designates the contaminated area where the user will enter the unit
- **Yellow** - designates the area where the user will wash off any contamination
- **Green** - designates the clean, post decontamination area

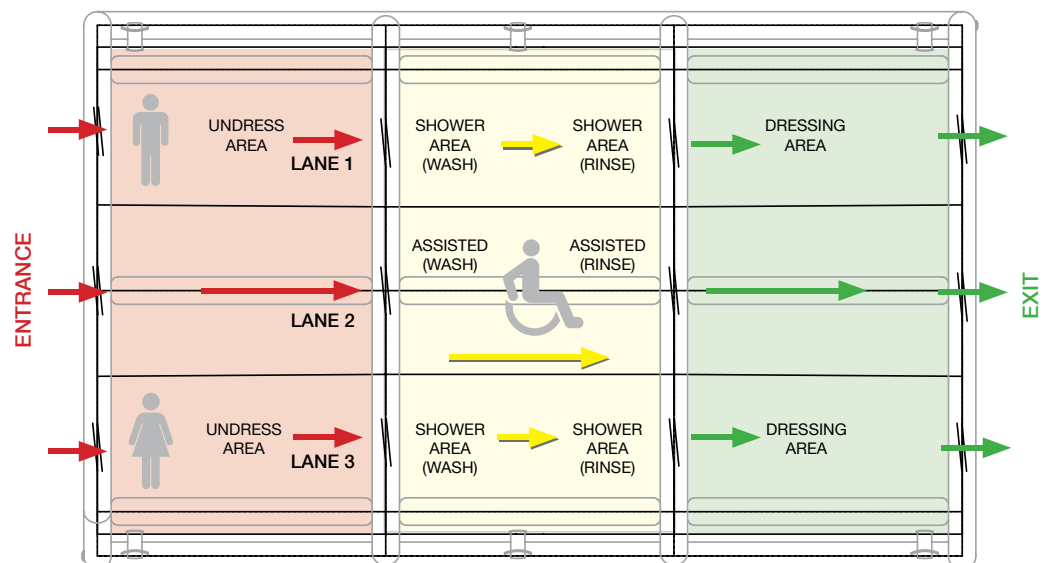

SYSTEM SCHEMATIC & COMPONENTS

Using a pillow tank water supply.

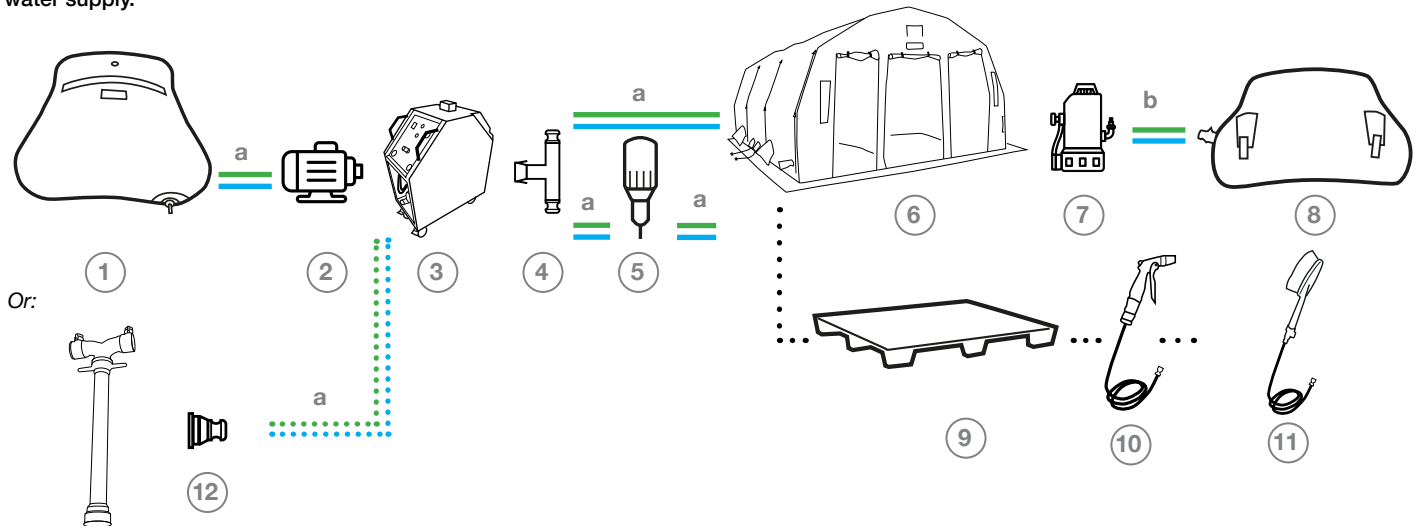

Using a tender or stand pipe water supply.

Pressure required: >2 Bar

If supply pressure is less than 2 bar 1x inlet water pump (2) will be required

 **CAMLOCK Coupling System**

For a system with CAMLOCK couplings throughout order codes in green

 **Storz Coupling System**

For a system with Storz D25 couplings throughout order codes in blue

SYSTEM COMPONENTS

1



Clean (Potable) Water Pillow Tank (1000 ltr)

- Other sizes available, see website for details

Quantity Required: x1

Product code:

With Camlock Coupling

WS0028

With Storz Coupling

WS0028/001

2



Inlet Water Pump

Quantity Required: x1

Product code:

With Camlock Couplings

240v DSA002

110v DSA010

With Storz Couplings

240v DSA002/001

110v DSA010/001

3



Water Heater

- Diesel and electric water heater max 50 l/min

Quantity Required: x1

Product code:

With Camlock Couplings

TBC

With Storz Couplings

TBC

4



T-Piece

- Required if the water heater does not have two separate outlets

Quantity Required: x1

Product code:

With Camlock Couplings









DSA009 (1xF & 2xM)

DSA009/002 (3xM)

With Storz Couplings

DSA009/001

SYSTEM COMPONENTS (CONTINUED)

- | | | | |
|---|--|---|--|
| <p>5</p>  | <p>Dosatron with Trolley -
Required if the water heater does not include an injector for detergent/neutraliser.
Quantity Required: x1
Product code:
With Camlock Couplings
DSA005
With Storz Couplings
DSA005/001</p> | <p>6</p>  | <p>Mass Decon Shower
Quantity Required: x1
Product code:
With Camlock Coupling
DSW027
With Storz Coupling
DSW027/001</p> |
| <p>7</p>  | <p>Submersible (Sump) Pump
Quantity Required: x1
Product code:
With Camlock Coupling
240v DSA004
110v DSA003
With Storz Coupling
240v DSA004/001
110v DSA003/001</p> | <p>8</p>  | <p>Dirty (Contaminated) Water Pillow Tank (1000 ltr)
- Other sizes available, see website for details
Quantity Required: x1
Product code:
With Camlock Coupling
WS0017
With Storz Coupling
WS0017/002</p> |
| <p>9</p>  | <p>Pallets for Decon Floor
Standard Pallet
Quantity Required: x6
Product code: 140065
Pallet with Pump Cut-Out
Quantity Required: x2
Product code: DSA011</p> | <p>10</p>  | <p>Spray Gun & Hose
Quantity: Up to x8
Product code: DSA008
Short Hose
DSA008/SHORT</p> |
| <p>11</p>  | <p>Spray Brush & Hose
Quantity: Up to x8
Product code: 180035
Short Hose
180035/SHORT</p> | <p>12</p>  | <p>Adapter
- To connect fire tender or stand pipe outlet to the decon system in place of a pillow tank and pump.
Quantity Required: x1
Product code:
<i>Various models available depending on outlet coupling - Contact sales for details & product codes</i></p> |

HOSES



- a Green Clean Water Hose (2m)**
Quantity Required: x4
Product code:
With Camlock Couplings
HS-05-02-02-22-22
With Storz Couplings
HS-05-02-02-23-23



- b Clear Dirty Water Hose (2m)**
Quantity Required: x1
Product code:
With Camlock Couplings
HS-06-06-02-22-22
With Storz Couplings
HS-06-06-02-23-23

ACCESSORY SCHEMATIC

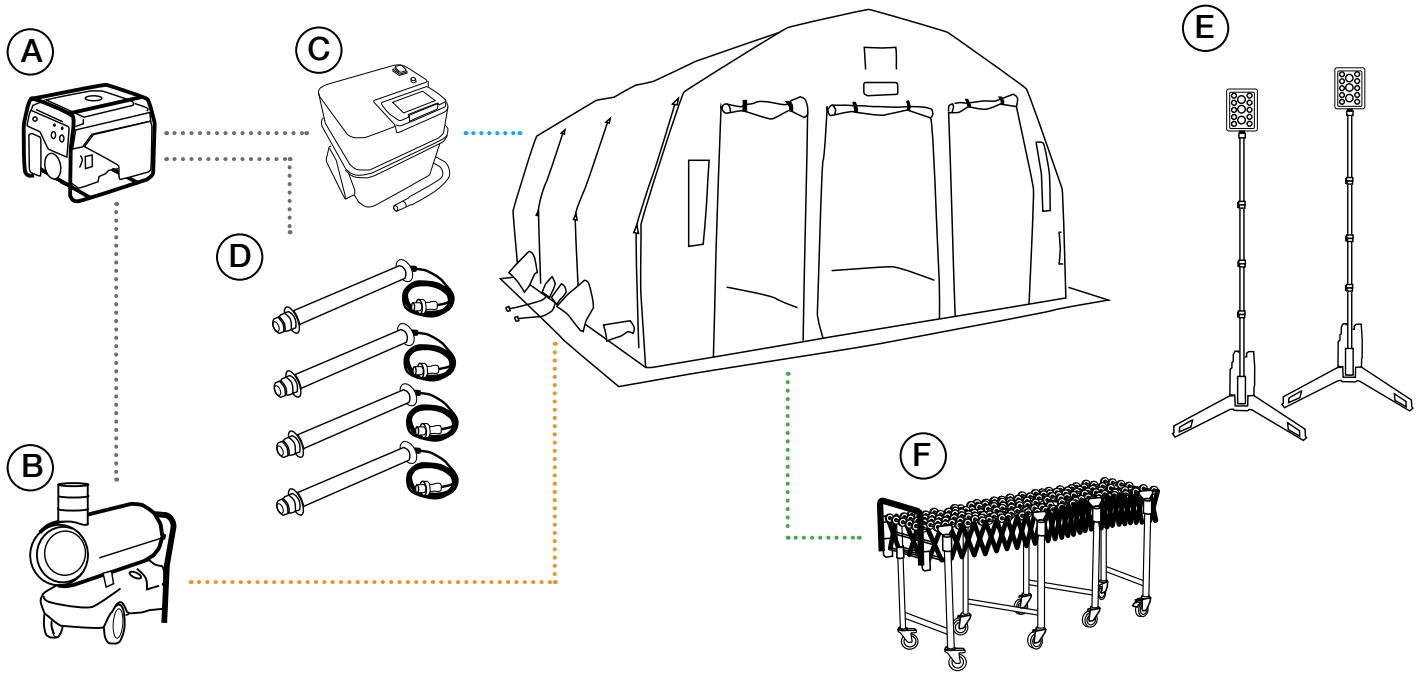

A



Generator
Ford 6kW 4-stroke petrol
(190500)

D



Waterproof LED Interior Lights
23W, 2300 Lumens
(4x SLZ2323/5/01DWD - IP67 Lamp)
(4x SLZ005 - Hanging kit)
110v 090068

B



Heater & Ducting
Oil fired space heater
20kw (68,000 BTU) heat output
SH9150
(1x Heater)
(1x High temp air hose)

E



Waterproof LED Exterior Rechargeable Flood Lights
Solaris Pro 18ah (090065)
Solaris Pro 36ah (090066)

C



Electric Inflator
GE1800 Standard
110v - TBC
230v - TBC

GE1800 ARS (Auto Refill System)
110v - 180052/001
230v - TBC

F



Patient conveyor - 3.7m
(1x DSA015)